



FlexCharge Smart Level 2 EV Charger

Installation & Usage Guide



Table of Contents

Safety Information	3
Specifications	5
Check Box Contents	6
Tools Needed	7
Installation Overview	8
Step 1: Download the APP (Smart Home Version)	8
Step 2: Download the OCPP Configuration Tool	8
Step 3: Powering the EV Charger	9
Step 4: Find a Place for the EV Charger	10
Step 5: Mark the Mounting Bracket Location	11
Step 6: Install the Mounting Bracket	11
Step 7: Install the Gun Cradle Beside the Charger	12
Step 8: Mount the EV Charger	12
Step 9a: Hardwired Instructions for Electricians	13
Step 9b: Plugged in Instructions for Electricians	17
Step 10: Complete Setup	20
Charging your Vehicle	21
EV Charger LED Lights	22
Troubleshooting Tips	23
FCC	24
Maintenance and Repair	25
Service	25

Important Safety Instructions

Instructions Pertaining To A Risk Of Fire Or Electric Shock!

Improper connection of the equipment - grounding conductor may result in a risk of electric shock, leading to death or serious injury. AA LED recommends that installation be performed by a licensed electrician or other qualified professional in accordance with the regional electrical code where it is being installed to ensure the AA LED EV Charger is properly grounded. Do not modify the provided plug – if it will not fit the outlet, have a proper outlet installed by a licensed electrician or other qualified professional.

Grounding Instructions

For Plugged-In Installation: This product must be grounded. If it should malfunction or break down, grounding provides a path of least resistance for electric current to reduce the risk of electric shock. This product is equipped with a cord having an equipment grounding conductor and a grounding plug. The plug must be plugged into an appropriate outlet that is properly installed and grounded in accordance with all local codes and ordinances.

Warning

Improper connection of the equipment-grounding conductor is able to result in a risk of electric shock. Check with a qualified electrician or serviceman if you are in doubt as to whether the product is properly grounded. Do not modify the plug provided with the product – if it will not fit the outlet, have a proper outlet installed by a qualified electrician.

For Hardwired Installation:

This product must be connected to a grounded, metal, permanent wiring system, or an equipment-grounding conductor must be run with the circuit conductors and connected to the equipment grounding terminal or lead on the product.

Important Safety Instructions

Instructions Pertaining To A Risk Of Fire Or Electric Shock!

- This product must be connected to a grounded, metal, permanent wiring system, or an equipment-grounding conductor must be run with the circuit conductors and connected to the equipment grounding terminal or lead on the product
- Read all the instructions before using this product.
- This device should be supervised when used around children. Do not put fingers into the electric vehicle connector.
- The AA LED EV Charger is intended for use with electric vehicles only. Specifically, it is intended only for charging vehicles not requiring ventilation during charging.
- Do not use the AA LED EV Charger in any manner other than specified in this installation guide. Refer servicing to qualified service personnel.
- Do not attempt to disassemble or repair any of the components of the AA LED EV Charger. There are no user serviceable parts inside.
- Do not use this product if the flexible power cord or EV cable is frayed, has broken insulation, or any other signs of damage.
- Do not use this product if the enclosure or the EV connector is broken, cracked, open, or shows any other indication of damage.
- Do not install the AA LED EV Charger in environments with explosive gas or vapors; nor where temperatures are outside its operating range of -22°F to 122°F (-30°C to 50°C).
- Use 105°C wire, 6 AWG copper for setting 48A rating intended for field wiring connection.
- Improper moving or storage of the AA LED EV Charger may result in damage to the product that could result in a risk of fire or electric shock during subsequent use.
- Handle charger and packaging with care and avoid dropping it. When moving or lifting the AA LED EV Charger, always grasp the unit by the charging station enclosure. Never carry or lift the AA LED EV Charger by either the power cable or charging cord.
- Store the AA LED EV Charger indoors and in its original packaging until it is ready to be installed. Storage temperature should be between -22°F to 122°F (-30°C to 50°C).

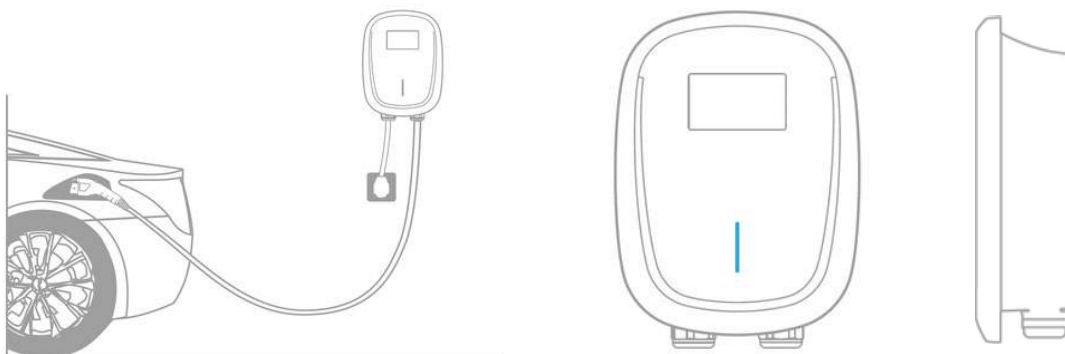

FlexCharge Specifications

Electrical Characteristics	<ul style="list-style-type: none">• Safety Rated: 48A Max• Single phase input: nominal voltage 208-240 VAC ~ 60 Hz• Power: 11.5 kW at 240 VAC
Input Cable	Hardwired by licensed electrician
Output Cable & Connector	<ul style="list-style-type: none">• 18 ft/5.5 m cable (25ft/7.5m optional)• SAE J1772 standard compliant• NACS Charging plug
App	<ul style="list-style-type: none">• Precision measurement of power, energy, voltage & current• Automated notifications: time-of-use in effect, start of charge, end of charge, unit offline, unit back online, car not plugged in by a set time
Smart Grid Connectivity	Built-in Wi-Fi (802.11 b/g/n/2.4GHz) / Bluetooth Connectivity
Firmware	Over-the-air (OTA) upgradeable firmware
Emissions Reduction	Available via optional software upgrade
Enclosure	<ul style="list-style-type: none">• Dynamic LED lights show charging status: standby, device connectivity, charging in progress, fault indicator, network connectivity• NEMA Enclosure Type 4: weatherproof, dust-tight• IK08: resistant polycarbonate case• Quick-release wall mounting bracket included• Operating Temperature: -22°F to 122°F (-30°C to 50°C)
Dimensions	Main enclosure: 12.8in × 9.7in × 3.8in (326mm × 247mm × 97mm)
Codes & Standards	NEC625 compliant, UL2594 compliant, OCPP 1.6J, ISO15118, FCC Part 15 Class B, Energy Star
Safety	ETL Listed
RFID	Optional
4G module	Optional
Warranty	2 years limited product warranty

FlexCharge Box Contents

Your new AA LED EV Charger contains the following items. If any of these items are missing or if you believe they've been damaged, call support immediately.

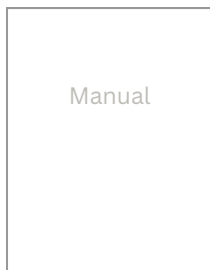
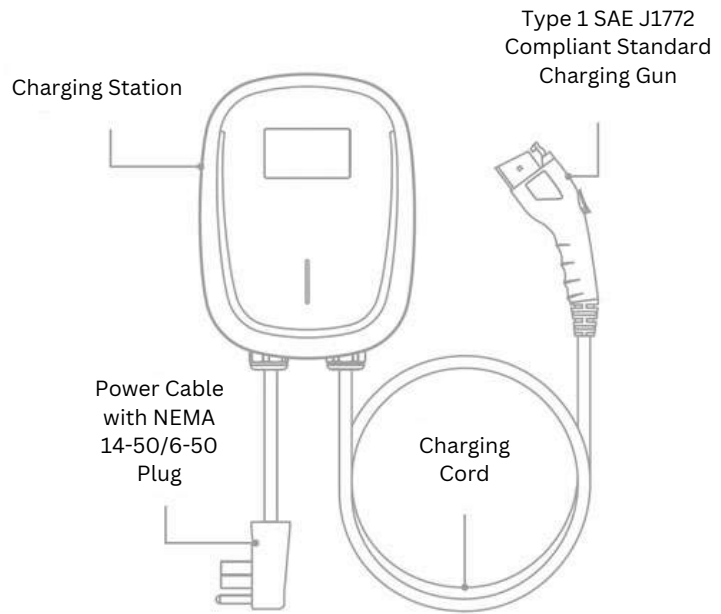

User Manual

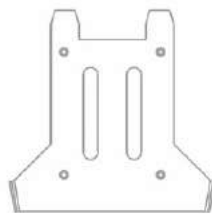

Mounting Bracket

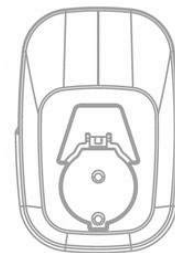

Gun Cradle



Drywall Anchors



Six (6) 7/32 inch #12 Phillips Screws



Two (2) M4X8 Hand Screws

Required Tools for Installation

Here are the tools you will need to install the EV Charger:



Phillips, flathead, and torx screwdrivers



Adjustable Wrench



IOS or Android Phone

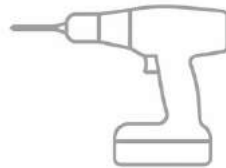

Drill with a 5/16" Drill Bit



Allen Wrench



Rubber Mallet



Bubble Level



Pencil

**Need more assistance?
Contact AA LED
Customer Service.**

www.aacharger.ca
416-493-6888
support@aaled.ca

616-618-620 Gordon Baker
Rd, Toronto, Ontario,
Canada, M2H 3B4

Step 1: Download the App (Smart Home Version) ---

- Use your phone to check the signal strength of your Wi-Fi network where the EV Charger will be installed. Low/no signal may require a Wi-Fi extender for the Charger to work.
- Use your phone or tablet to scan the QR code below. Download the EV Charging app onto your phone or tablet from the Apple App Store or from Google Play, create an account and begin the setup process.



Step 2: Download the OCPP Configuration Tool ---

- Use your phone or tablet to scan the QR code below. Download the OCPP Configuration Tool App onto your phone or tablet from the Apple App Store or from Google Play, create an account and begin the configuration process.



Step 3: Powering the EV Charger

- For Hardwired Installation: see Step 9a
 - EV Charger can supply a maximum charge of 48A to the EV
 - Requires a dedicated dual pole breaker. We recommend 60A.
 - CAUTION: To reduce the risk of fire, connect only to a circuit provided with 60 amperes maximum branch circuit over current protection in accordance with the National Electrical Code, ANSI/NFPA 70 and the Canadian Electrical Code, Part I, C22.1.
 - To reduce the risk of fire, connect only to a circuit provided with branch circuit over current protection in accordance with the CSA C22.1-15 Canadian Electrical Code, Part 1 (Canada) or NOM-001-SEDE Electrical installations (Utility) (Mexico) or ANSI NFPA 70 National Electrical Code (USA)
-
- For Plugged-in installation: see Step 9b
 - EV Charger can supply a maximum charge of 40A to the EV
 - Requires a dedicated, 50A dual pole breaker.
 - Requires a NEMA14-50R/6-50R receptacle outlet.

Dedicated Breaker	Charge Power @ 240V	
15A	2.9kW	12A
20A	3.8kW	16A
25A	4.8kW	20A
30A	5.8kW	24A
35A	6.7kW	28A
40A	7.7kW	32A
45A	8.6kW	36A
50A	9.6kW	40A
60A	11.5kW	48A
100A	19.2kW	80A

Step 4: Find a Place for the EV Charger

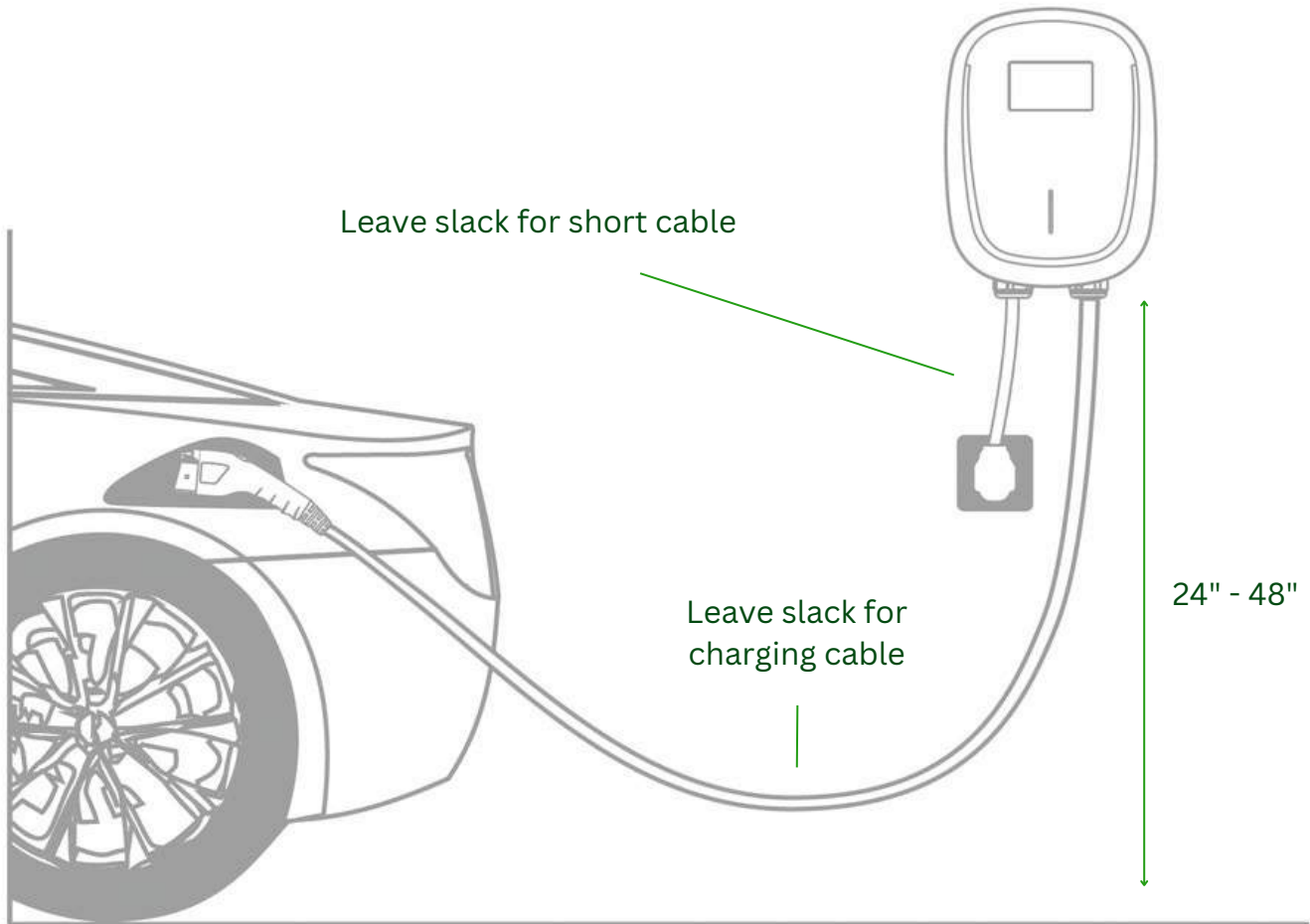

This device shall be mounted at a sufficient height from grade such that the height of the storage means for the coupling device to be located between 24"(600 mm) and 48" (1.2 m) from grade; the distance from the vehicle allows slack for charging cable; temperatures are between -22°F to 122°F; the charger is within range of Wi-Fi signal; and if plugged-in, the distance from the NEMA outlet allows slack for a short cable.

Step 5: Mark the Mounting Bracket Location

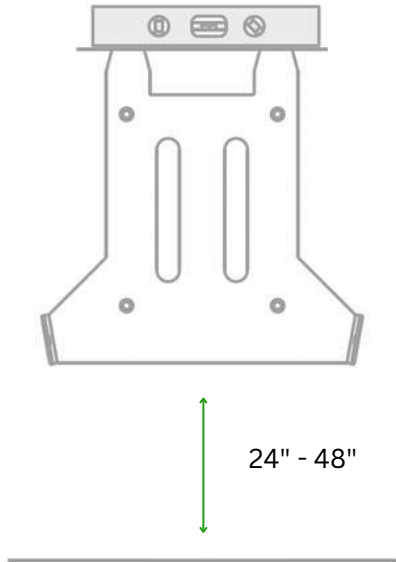

On the plasterboard/drywall where the charger will be installed, use a bubble level to draw a horizontal line where the top of the EV Charger will sit on the wall, ensuring it is mounted at a sufficient height from grade such that the height of the storage means for the coupling device to be located between 24"(600 mm) and 48" (1.2 m) from grade and allows slack for the NEMA cable if it will be plugged in. Then, align the top of the mounting bracket to the line and mark the 4 mounting holes.

Step 6: Install the Mounting Bracket

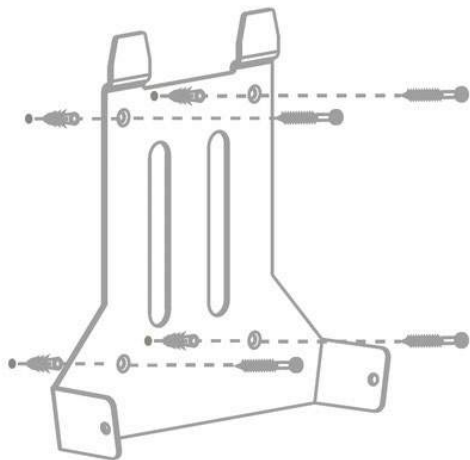

For each mark, drill a 5/16" hole in the wall. Use a Rubber Mallet to tap in the 4 drywall anchors. Install the bracket with 4 Phillips screws into the anchors.

Step 7: Install the Gun Cradle Beside the Charger

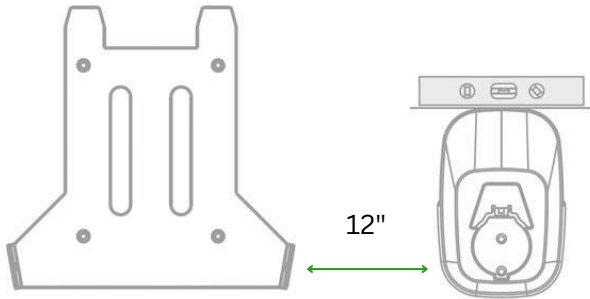

Use a bubble level to draw a horizontal line at least 12" away from the mounting bracket at the height you'd like the cradle beside your EV Charger. Holding the gun cradle up to your line, mark the top two and bottom mounting holes of the gun cradle. If the gun cradle is being installed on the wall or on the power distribution cabinet or board, drill a 5/16" hole in the wall for each mark. Use a Rubber Mallet to tap in 2 drywall anchors. Install the gun cradle with 2 Phillips screws into the anchors.

Step 8: Mount the EV Charger

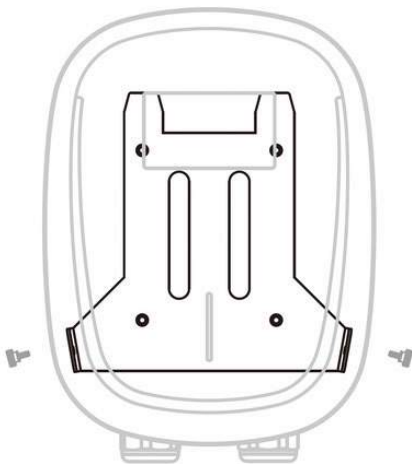

Use the 2 M4X8 hand-screws to install the EV Charger on the mounting bracket.

Step 9a-1: Hardwired Instructions for Electricians

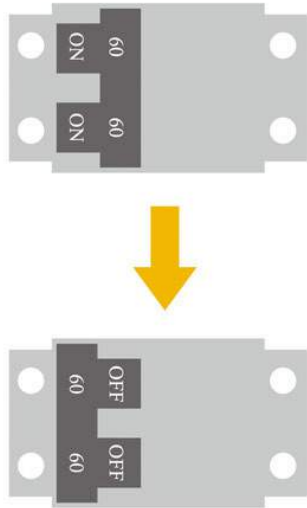

A licensed electrician or other qualified professional can follow these instructions to hardwire the EV Charger to a breaker. If you plan to power your EV Charger with a NEMA 14-50R/6-50R receptacle outlet, skip to Step 9b. First, turn off the dedicated dual-pole breaker that will power the EV Charger.

Step 9a-2: Hardwired Instructions for Electricians

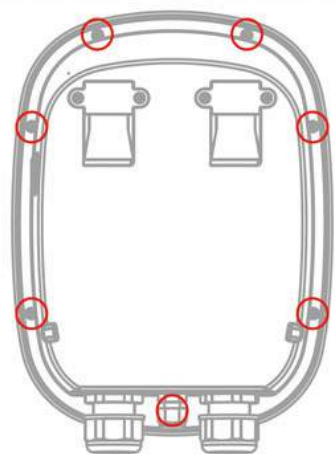

From the back of the EV Charger, use the Allen wrench to remove the 7 screws to detach the front cover. Use the Adjustable wrench to remove the waterproof joint.

CAUTION: there's a cable connecting the cover to the circuit board in the Charger. To remove the cable, gently grab the cable bundle and pull it away from the circuit board.

Step 9a-3: Hardwired Instructions for Electricians

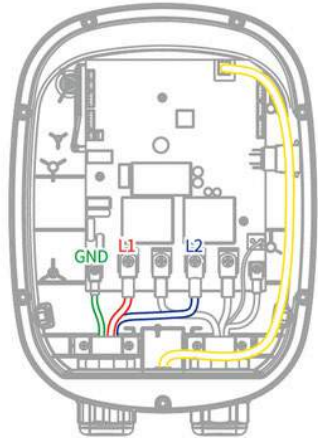

Unscrew the screws for terminals L1, L2, and GND, to remove the NEMA cable wires.

Ethernet Cable As Shown

Step 9a-4: Hardwired Instructions for Electricians

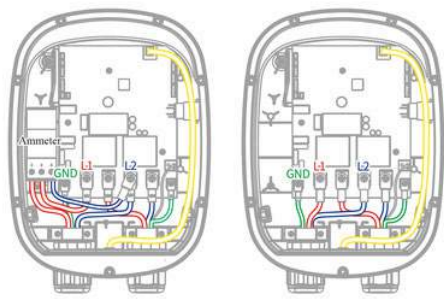

Equipped
With An
Anmeter

Without An
Anmeter

Unscrew the screws to remove the clamp securing NEMA cable. Then, remove the NEMA cable from the assembly. Finally, unscrew the nut holding the cable gland in place and remove it from the assembly.

Step 9a-5: Hardwired Instructions for Electricians

Using 1-1/4" conduit and proper fittings for the connections, use copper conductor only, 105°C, 6 AWG for setting 48A rating from both phases of the breaker along with a ground/earth lead into the EV Charger assembly. Put the phase 1 lead into terminal L1, the phase 2 lead into terminal L2, and the ground into terminal GND and secure them with the screws, applying a tightening torque of 1.2 Nm.

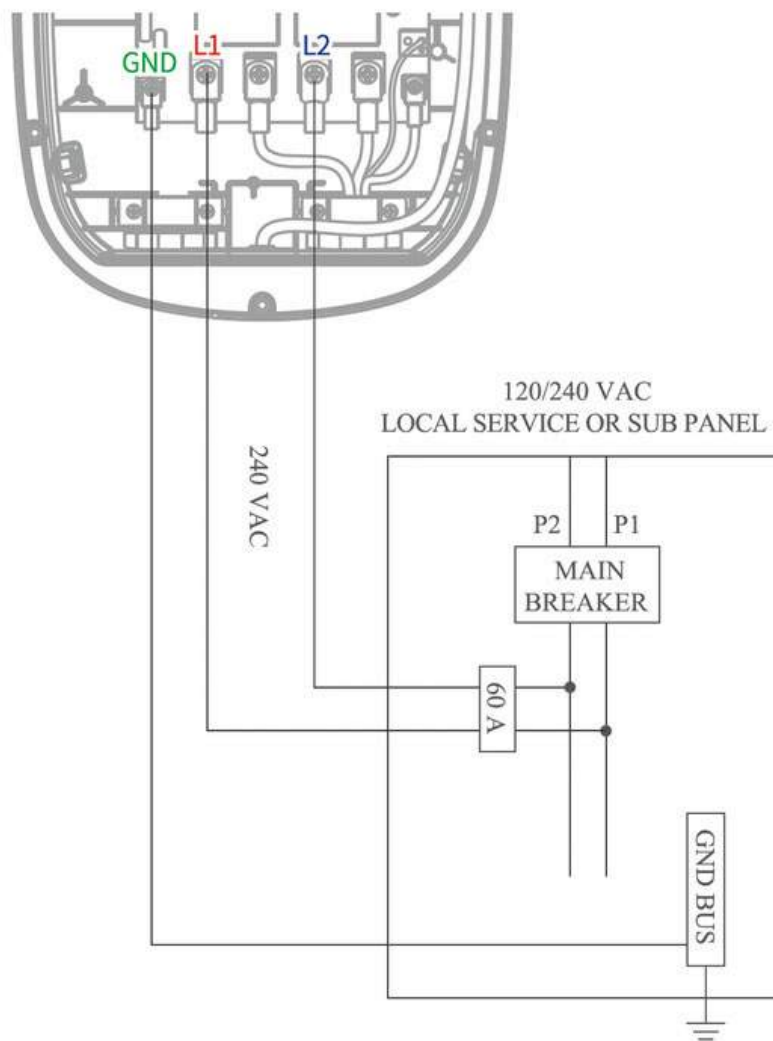

Step 9a-6: Hardwired Instructions for Electricians

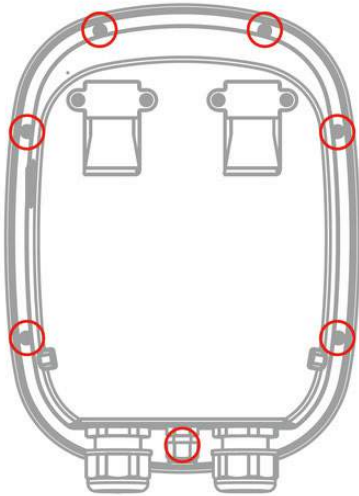

Gently reattach the cable to the cover and the circuit board. Then, from the back of the EV Charger, use the Allen wrench to replace the 7 screws to reattach the front cover.

Step 9a-7: Hardwired Instructions for Electricians

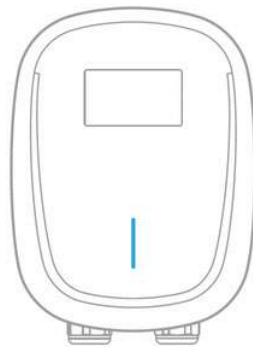
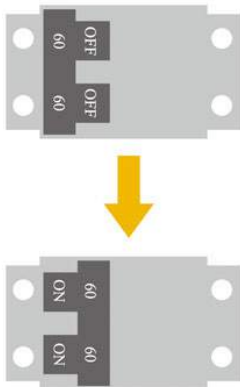

Turn on the breaker and ensure that the power light on the front of the EV Charger is illuminated.

Step 9b-1: Plugged in Instructions for Electricians



If a NEMA 14-50R receptacle outlet is not already at the EV Charger location, a licensed electrician or other qualified professional can follow these instructions to install one. First, turn off the dedicated dual-pole breaker that will power the EV Charger.



If a NEMA 6-50R receptacle outlet is not already at the EV Charger location, a licensed electrician or other qualified professional can follow these instructions to install one. First, turn off the dedicated dual-pole breaker that will power the EV Charger.

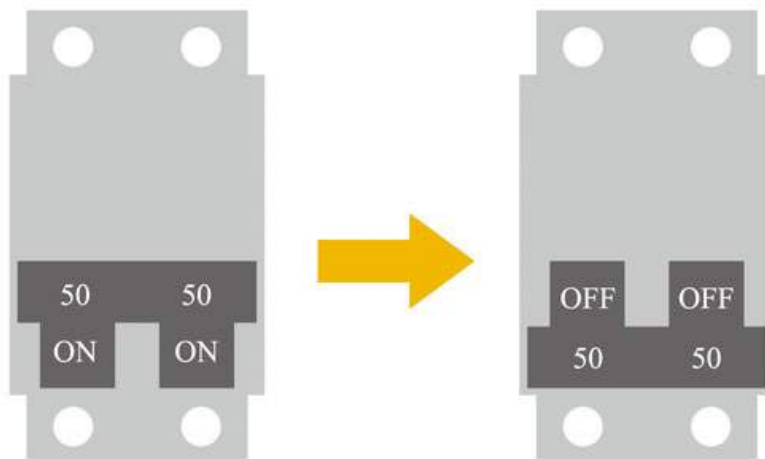

Step 9b-2: Plugged in Instructions for Electricians

Install a NEMA14-50R receptacle outlet with the ground facing downward ensuring the distance between the NEMA outlet and the EV Charger allows slack for a short cable. Bring leads from both phases of the breaker along with a ground/earth lead to the outlet and connect them. Neutral is not required.

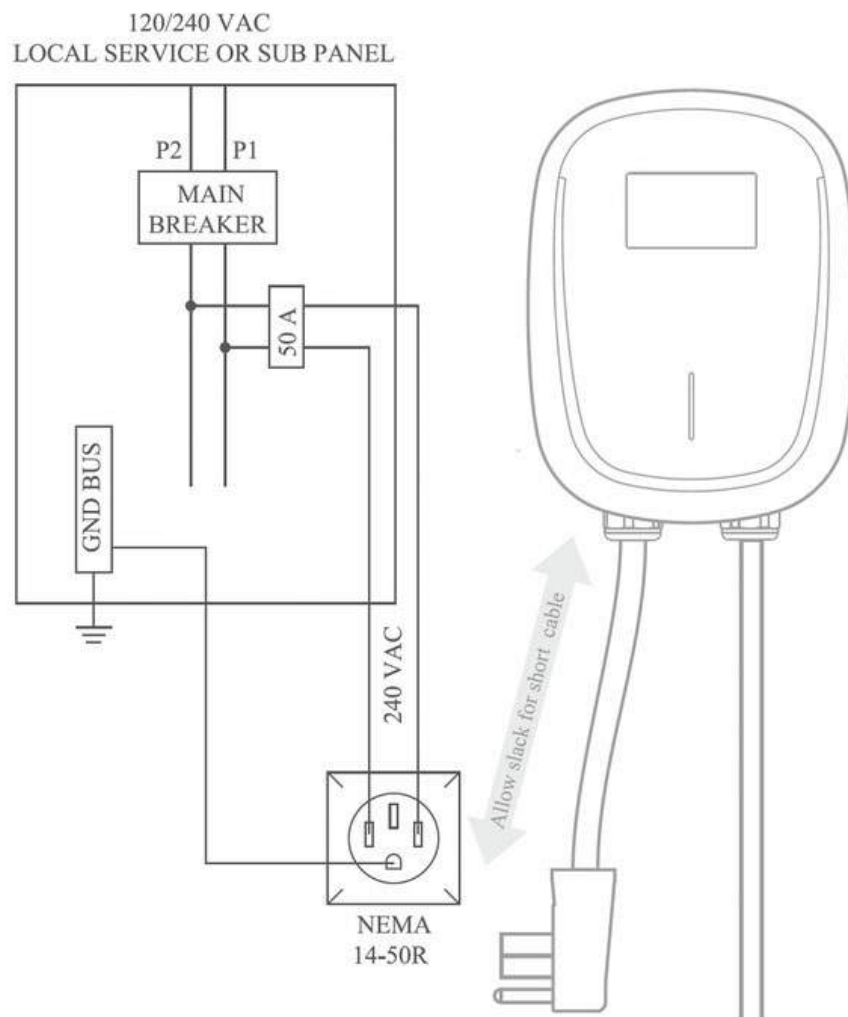

Step 9b-3: Plugged in Instructions for Electricians

Install a NEMA6-50R receptacle outlet with the ground facing downward ensuring the distance between the NEMA outlet and the EV Charger allows slack for a short cable. Bring leads from both phases of the breaker along with a ground/earth lead to the outlet and connect them. Neutral is not required.

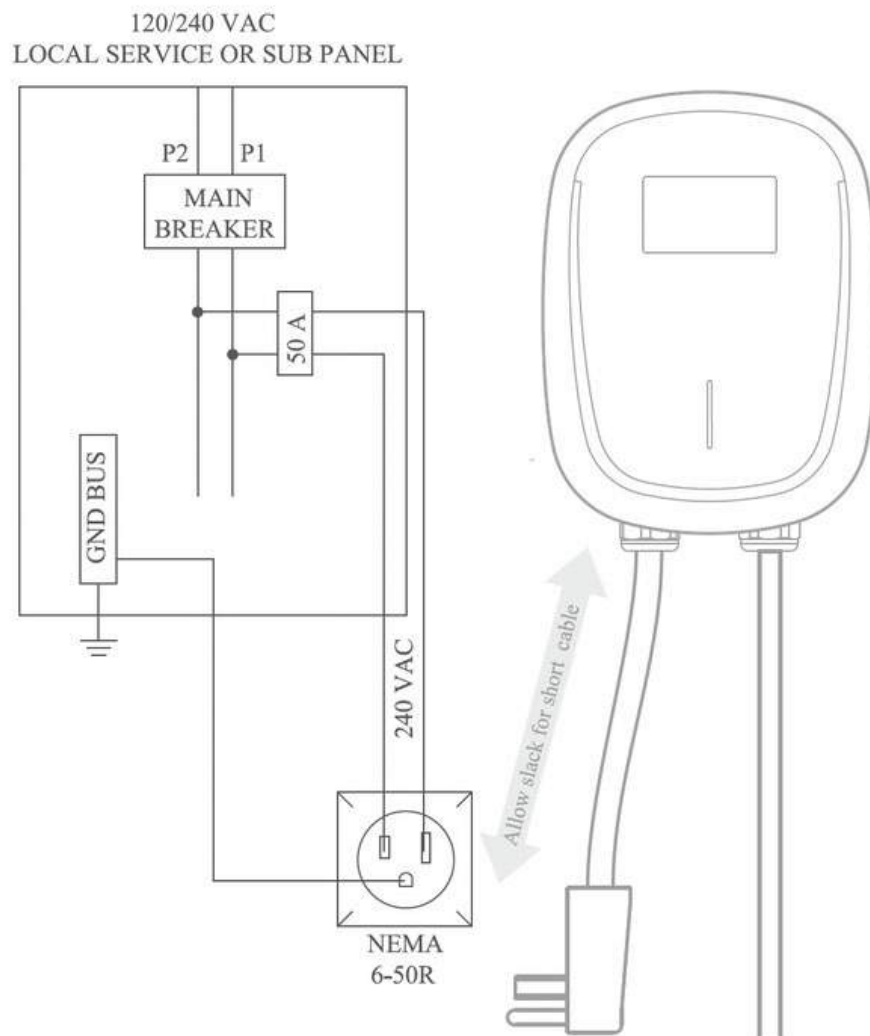

Step 9b-4: Plugged in Instructions for Electricians

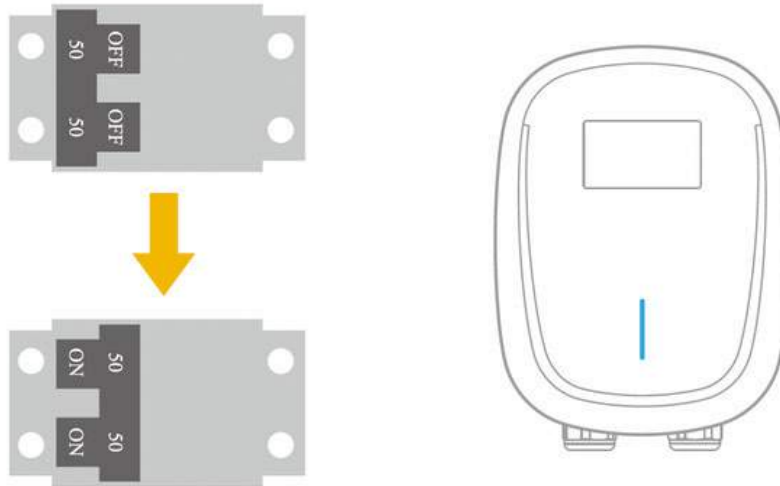

Plug in the NEMA 14-50P/60-50P plug from the EV Charger into the receptacle outlet. Turn on the breaker and ensure that the power light on the front of the EV Charger is illuminated.

Step 10: Complete Set Up



Your EV Charger is now ready to charge your vehicle. Factory setting: based on the maximum EV charger capacity that the car system will accept. The default factory setting of the charging mode is Plug and Play. To raise or lower the charge rate to match your breaker size and to take advantage of the numerous other features through EV Charger APP or OCPP Configuration Tool, follow the corresponding steps in the User Instruction Manual to make changes.

Charging your Vehicle

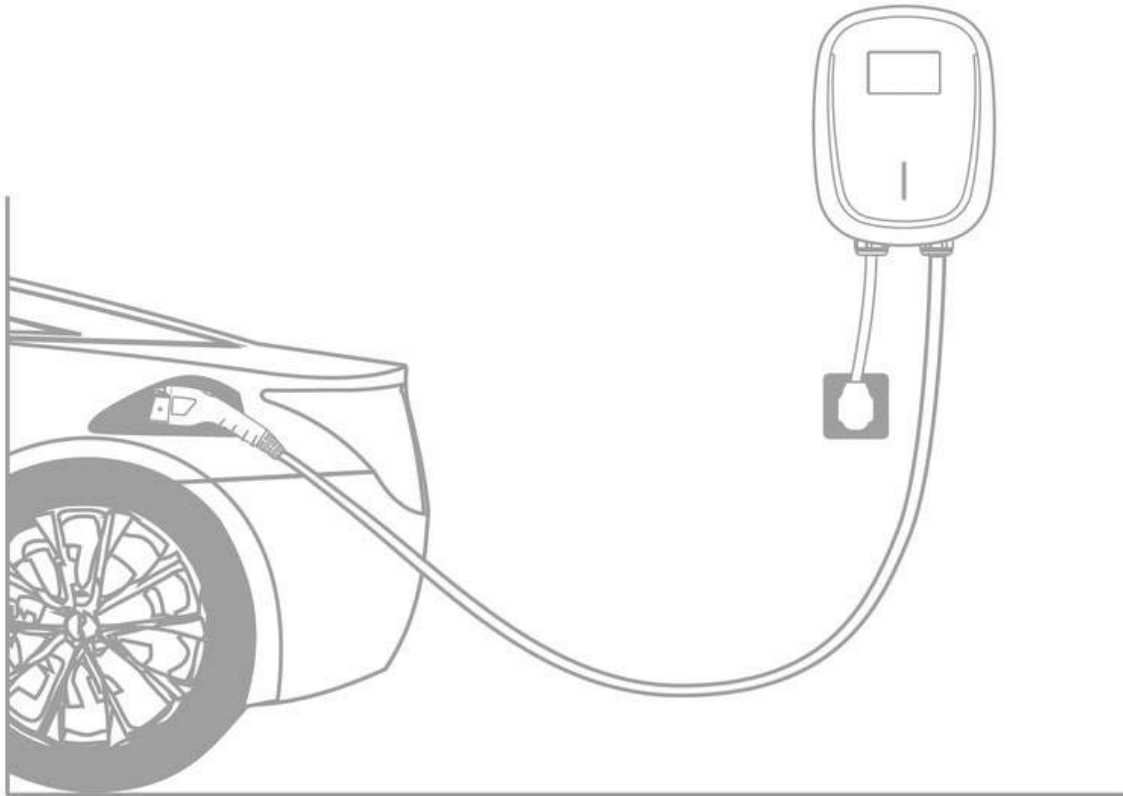

Factory setting: based on the maximum EV charger capacity that the car system will accept. You can raise or lower this rate through the AA LED APP or OCPP Configuration Tool. Default factory setting of the charging mode is Plug and Play. If it is a smart home charger, to switch to APP mode, please refer to the AA LED APP instruction guide. If it is a commercial charger (OCPP version), switch the mode through the AA LED OCPP Configuration Tool on your phone or tablet.

To start charging the vehicle, open the port door and plug the EV Charger gun into the port. You will see the charge light on the EV Charger switch to solid green when it is connected to the vehicle. It will begin to flash green as the vehicle charges.

Additionally, most EVs have indicator lights on the dashboard to let you know that you are charging. Do not attempt to drive your vehicle while the charge cable is connected to your vehicle.

CAUTION: Do not touch and use this product when in case of failure. It is required to disconnect the power supply or have it handled by professionals.

EV Charger LED Lights

Power	
Off	Charger does not have power
Solid Blue	Charger has power
Charge	
Off	Idle Mode
Flashing Green	Charging Mode
Solid Green	Pre-Charge Mode
Wi-Fi/4G	
Off	Not connected to Wi-Fi/4G network
Soft White	Connected to Wi-Fi/4G network
Fault	
Red light always on	Reset switch failure
Red light flashing every 3 seconds (once)	Input voltage is too high. If plugged in, check that the NEMA14-50P or NEMA6-50P is plugged in securely. Check the supply breaker in your breaker panel for damage and replace if necessary. If issue persists, contact Support.
Red light flashing every 3 seconds (twice)	Input voltage is too low. If plugged in, check that the NEMA14-50P or NEMA6-50P is plugged in securely. Check the supply breaker in your breaker panel for damage and replace if necessary. If issue persists, contact Support.
Red light flashing every 3 seconds (three times)	Output over current. Unplug from car. Disconnect charger from power. Confirm there is no visible damage or foreign material in the EV gun. Return power to charger. If issue persists, contact Support.

EV Charger LED Lights Continued

Fault	
Red light flashing every 3 seconds (four times)	Charger has exceeded nominal temperature. Ensure the charger is installed where ambient temperatures will not exceed 122°F (50°C). If issue persists, contact Support.
Red light flashing every 3 seconds (five times)	Current leakage. Unplug from car. Disconnect charger from power. Confirm there is no visible damage or foreign material in the EV gun. Return power to charger. If issue persists, contact Support.
Red light flashing every 3 seconds (six times)	Charger is not grounded Ensure that the EV Charger is properly wired and grounded. Check the line and neutral connections, as they may be reversed in the adapter or outlet. Unplug and reboot EV charger. If issue persists, contact Support.
Red light flashing every 3 seconds (seven times)	CP line not properly connected.
Red light flashing every 3 seconds (eight times)	Relay fused in position. Disconnect from power immediately. Contact Support.

Troubleshooting Tips

The EV Charging APP is not finding my EV Charger after I've installed it.

Ensure that the latch on the EV charging cable handle is locked into place. If the handle is not latched securely, the vehicle will not charge. If the latch is pressed down during charging, charging automatically stops.

Ensure that the vehicle is not set up to begin charging at a specific time of day.

Ensure the Charger has power:

- Check for a green power light.
- Check the EV Charger is wired properly.
- Check that the breaker powering the EV Charger is turned on.

Ensure your phone can connect to the EV Charger:

- Check that your phone's Bluetooth is on.
- Try power cycling the breaker to which the EV Charger is connected.
- Try restarting the EV Charging APP.
- Try rebooting your phone.

FCC

The AA LED EV Charger complies with Part 15 of the FCC Rules / Industry Canada license-exempt RSS standard (s). Operation is subject to the following two conditions: (1) this device may not cause harmful interference, and (2) this device must accept any interference received, including interference that may cause undesired operation.

This equipment has been tested and found to comply with the limits for a Class B digital device, pursuant to part 15 of the FCC Rules. These limits are designed to provide reasonable protection against harmful interference in a residential installation. This equipment generates uses and can radiate radio frequency energy and, if not installed and used in accordance with the instructions, may cause harmful interference to radio communications. However, there is no guarantee that interference will not occur in a particular installation. If this equipment does cause harmful interference to radio or television reception, which can be determined by turning the equipment off and on, the user is encouraged to try to correct the interference by one or more of the following measures:

- Reorient or relocate the receiving antenna.
- Increase the separation between the equipment and receiver.
- Connect the equipment into an outlet on a circuit different from that to which the receiver is connected.
- Consult the dealer or an experienced radio/TV technician for help.

To satisfy FCC / IC RF exposure requirements, a separation distance of 20cm or more should be maintained between the antenna of this device and persons during device operation. To ensure compliance, operations at closer than this distance is not recommended.

CAUTION: Changes or modifications not expressly approved by the party responsible for compliance could void the user's authority to operate the equipment.

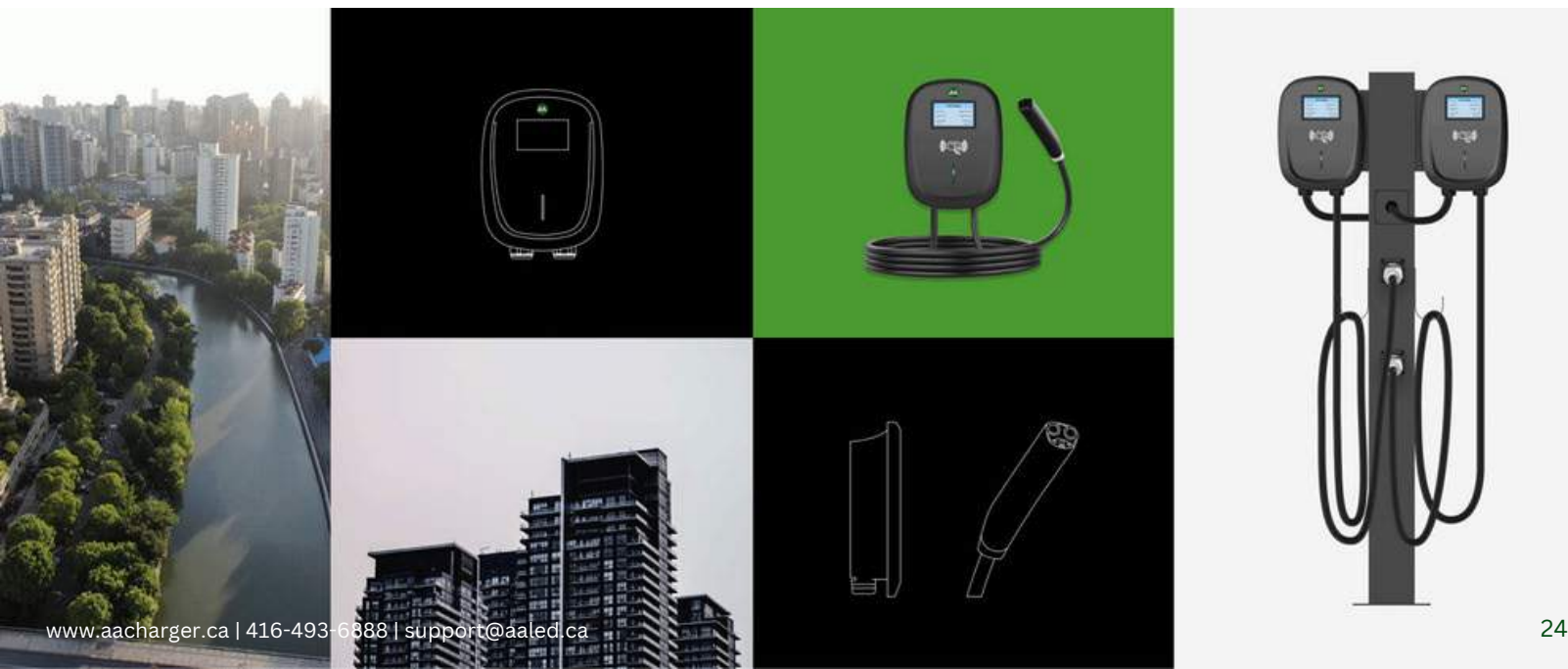

Maintenance & Repair

Always ensure that after charging, the charging cable is wrapped around the Wall Connector. Regularly inspect the Wall Connector and charging cable for signs of damage. If damage is found, contact AA LED.

The Wall Connector contains no user-serviceable components. If the unit is not operating correctly, contact AA LED.

Wipe the outside of the wall Connector, the charging cable, and the connector end of the charging cable with a clean dry cloth to remove any accumulation of dust and dirt.

WARNING: Turn off input power at the circuit breaker before cleaning the Wall Connector.

WARNING: Do not use cleaning solvents, scouring, powder, or any type of abrasive pad to clean the wall connector, its charging cable, or the vehicle's charging port.

CAUTION: To reduce the risk of electrical shock or equipment damage, do not allow liquid to enter the Wall Connector while cleaning it.

Service

Need more assistance? Contact AA LED Customer Service.

www.aacharger.ca
416-493-6888
support@aaled.ca

616-618-620 Gordon
Baker Rd, Toronto,
Ontario, Canada, M2H 3B4

