

LED AREA LIGHT



MODEL: AL150WUCCTW

SKU: 700057UCCTW

LED AREA LIGHT

ELAKEVIEW ENTERPRISE LTD.

PRODUCT DESCRIPTION

The Elakeview Nebula LED Area Light developed with rugged, Die-Cast aluminum housing, built-in 6KV/10KV surge protector, class 2 driver. It has universal power input from AC120-347V, field CCT/wattage selectable feature, and integrated receptacle for photocell/motion sensor that satisfies all high quality required exterior lighting projects.



HIGHLIGHTS

- AC120-347V
- 6KV/10KV surge protector, Class 2 driver w/overtemperature protection
- Color temperature Selectable: 3500/4100/5000K
- Wattage Selectable: 100/120/150W
- 0- 10V Continuous dimming
- W/receptacle f/Photocell/motion sensor
- Pressure Relief Respirator
- Quick release access cover
- Various mounting options
- L70 - 70,000 Hours
- 10 Year warranty
- DLC 5.1 P, IP65 rated, cETL Listed



APPLICATIONS

Designed for commercial and industrial exterior light applications.

ORDERING INFORMATION

ORDER SKU	DLC MODEL#	CRI	INPUT VOLTAGE	POWER	EFFICACY	DELIVERED LUMENS	CCT	FINISH	SIZE
700056UCCTW	AL100WUCCTW	>70	AC120-347V	60/80/100W	140/160/150 LM/W	9000/12000/15000LM	3500/4100/5000K	BRONZE	330*592*64mm
700057UCCTW	AL150WUCCTW	>70	AC120-347V	100/120/150W	140/160/150 LM/W	15000/18000/22500LM	3500/4100/5000K	BRONZE	330*592*64mm
700057UCCTW-WHITE	AL150WUCCTW	>70	AC120-347V	100/120/150W	140/160/150 LM/W	15000/18000/22500LM	3500/4100/5000K	WHITE	330*592*64mm
700015UCCTW	AL200WUCCTW	>70	AC120-347V	150/200/240W	140/160/150 LM/W	22500/30000/36000LM	3500/4100/5000K	BLACK	330*592*64mm
700058UCCTW	AL300WUCCTW	>70	AC120-347V	300/420W	140/160/150 LM/W	45000/63000LM	3500/4100/5000K	BLACK	632*755*60mm
7000059AL	U Bracket for 700015UCCTW, 700056UCCTW, 700059UCCTW, 700058UCCTW								
700060SU	Slip fitter for SKU 700056UCCTW, 700057UCCTW, 700015UCCTW, 700058UCCTW								
700060U3IN1	3 in1 universal slip fitter/arm mount for round & flat pole, f/ SKU: 700056UCCTW, 700057UCCTW, 700015UCCTW, 700058UCCTW								
700060U3IN1-WHITE	3 in1 universal slip fitter/arm mount for round & flat pole, white finish, f/ SKU: 700057UCCTW-WHITE,								
700061SU	Adjustable horizontal arm for SKU 700056UCCTW, 700057UCCTW, 700015UCCTW, 700058UCCTW								
Photocell-ANT54TPC	Photocell for area light, DC12-24V, 25mA, Max 0,4W, -40C to+70C: for SKU 700056UCCTW, 700057UCCTW(white), 700015UCCTW, 700058UCCTW. MF code: ANT-5-4T-PC								

REV 1

PRODUCT FEATURE

- AC120-347V
- 6KV/10KV surge protector, Class2 driver w/overtemperature protection
- Wattage selectable: 100/120/150W
- Color temperature Selectable: 3500/4100/5000K
- Efficacy - 140/160/150 LM/W
- CRI > 70
- 0 - 10V Continuous dimming.
- Operating temperature: -40° C to 40° C
- Pressure Relief Respirator
- Quick release access cover
- W/receptacle f/Photocell/motion sensor
- Various mounting options
- Aluminum die-cast housing with heat sink
- Easy to install and operate
- DLC 5.1 P, IP65 rated, cETL Listed
- 10 years warranty, 70,000 hrs Lifespan

PRODUCT SPECIFICATIONS

WATTS	DELIVERED LUMENS	COLOR TEMP	EFFICACY	BEAM ANGLE	CRI	VOLTAGE	POWER FREQ	POWER EFFICIENCY	POWER FACTOR	THD	COLOR
100W	15000LM	3500K	140LM/W	T3	>70	AC120-347V	60HZ	99%	≥90%	≤20%	BRONZE
120W	18000LM	4100K	160LM/W								
150W	22500LM	5000K	150LM/W								

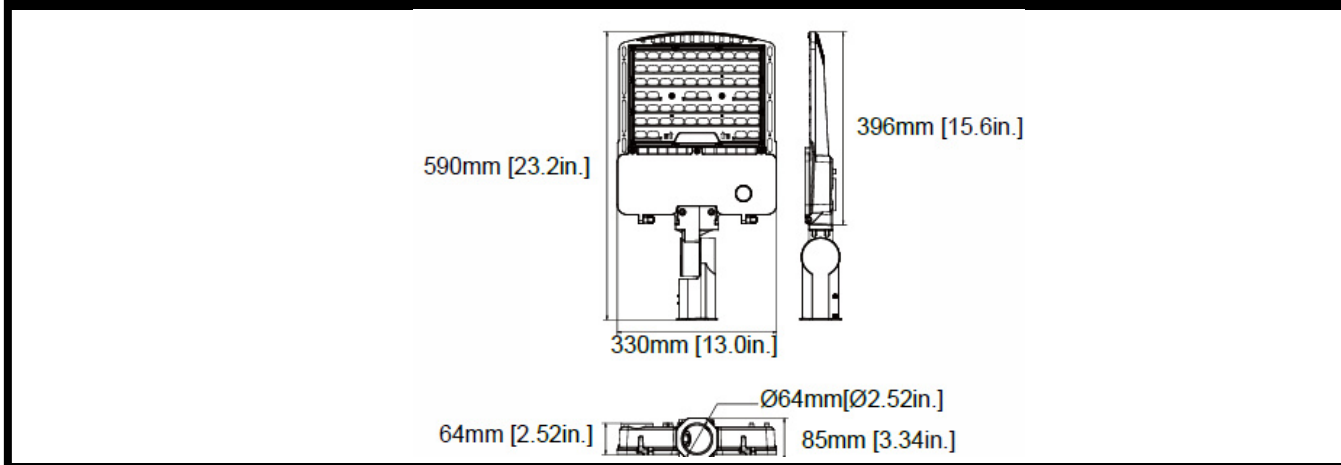

DIMENSIONS



MOUNTING OPTIONS

			
Parts	U Bracket	Slip Fitter	Adjustable Horizontal Arm
SKU	700059AL	SKU	700060HG
SKU		SKU	700061HG
SKU		SKU	700060U3IN1

OPTIONAL ACCESSORIES

		
Remote Control	Dimming Motion Sensor	Photocell
RC-100	HBUMSENSOR-DC12V	Photocell-ANT54TPC

LED AREA LIGHT **ELAKEVIEW ENTERPRISE LTD.**

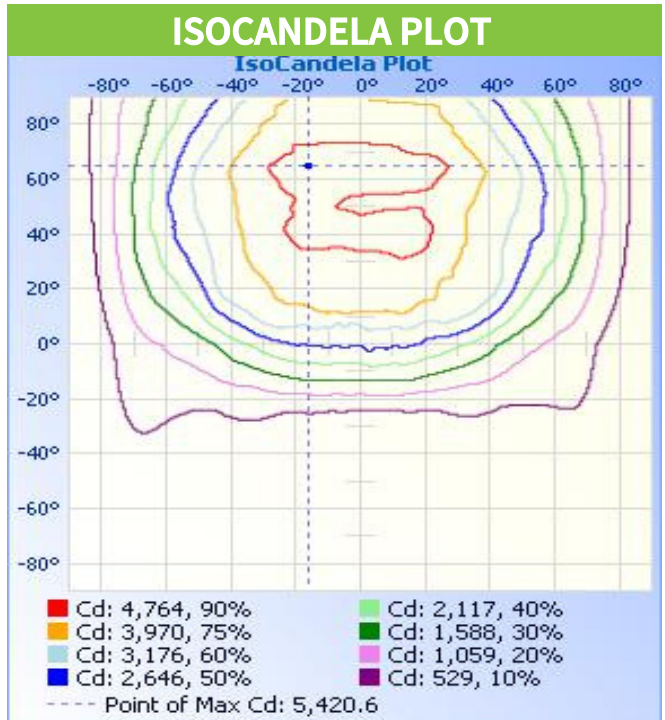
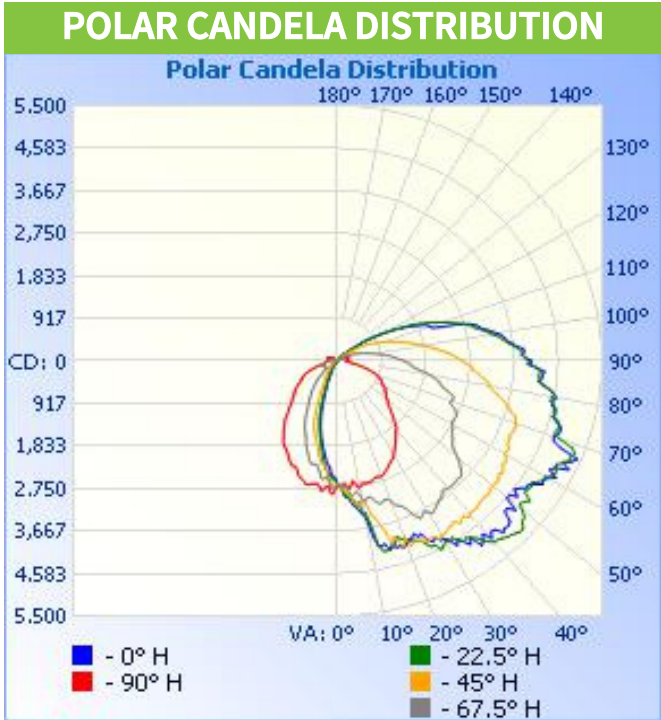

PHOTOMETRICS

Mester offers a complete set of optical systems to meet every site lighting requirement. These systems provide remarkable flexibility in precisely matching light distribution patterns to specific site requirements.

Type 3 optics produce an asymmetrical pattern that directs the majority of the light forward and equally on both sides of the luminaire. In a back-to-back configuration, it creates a rectangular pattern which can extend pole spacings.

Type 4 is suitable for applications where light is primarily required forward with minimal backlight. Typical installations include perimeter poles.

Type 5 optics produce a symmetrical square distribution pattern that distributes light equally on all sides of the luminaire. Type 5 luminaires is universal for most area lighting applications

